



THIS INFORMATION IS CONFIDENTIAL AND PROPRIETARY TO CW INDUSTRIES INCORPORATED AND ITS AFFILIATES. IT MAY NOT BE DISCLOSED TO ANYONE, OTHER THAN CW INDUSTRIES PERSONNEL, WITHOUT WRITTEN AUTHORIZATION FROM CW INDUSTRIES INCORPORATED, SOUTHAMPTON, PENNSYLVANIA USA.

Rating	16(4)A 250V AC	 	Mounting Hole	Circuit
Contact Resistance	50m ohm Max.			
Insulation Resistance	DC 500V 100M ohm Min.			
Dielectric Strength	AC 1500V 1 minute			
Switch Function	4P DPST ON - (OFF)			
Operation Temp.	0° C ~ 85° C			

() = Momentary Function

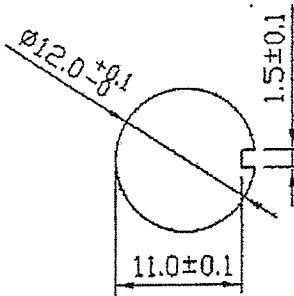
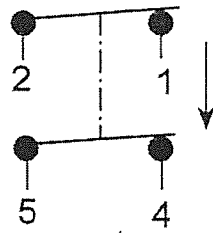
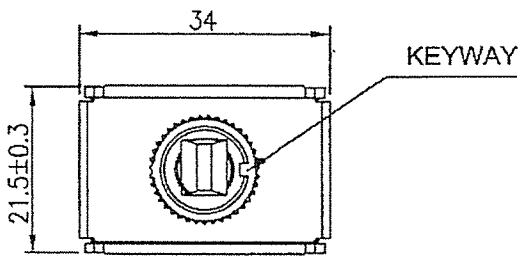

MATERIAL:

- Frame: Nylon 6/6, Black
- UL Flame: 94-V0
- Lever: Nylon 66+30%GF
- UL Flame: 94-V0
- Terminal: Copper Alloy

Water proof and Dust Proof
to fit IP-56

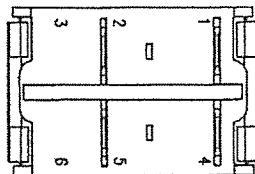
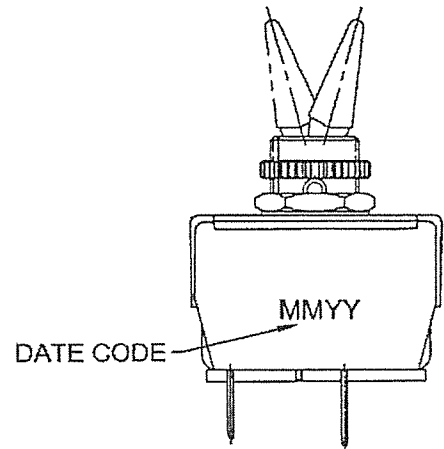
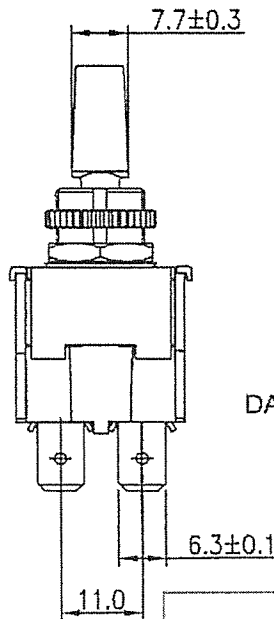
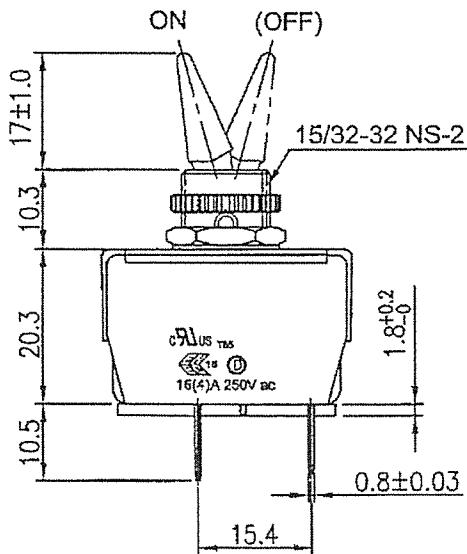

Series		Lever Type Plastic		Function		Term. Type .250" SQ		No Barrier	
GTS448	Q	3	01	AHR	Knurl Nut	Hex Nut			

Tolerances Unless Otherwise Specified +/-0.5.
RoHS Compliant
R13-448Q-3-01A-HR

- 2 Updated Order Chart, SCI part number & CWI logo APhilip 02/06/23
- 1 Updated material notes. 3-21-13.

CW INDUSTRIES
Southampton, Pa. 18966
Tel 215.355.7080/www.cwind.com

Date Drawn: 8/13/12

Rev. 2

Unit: mm

Checked By: *G. Gold*

Title: **TOGGLE SWITCH**

CW P/N: **GTS448Q301AHR**