

THIS INFORMATION IS CONFIDENTIAL AND PROPRIETARY TO CW INDUSTRIES INCORPORATED AND ITS AFFILIATES. IT MAY NOT BE DISCLOSED TO ANYONE, OTHER THAN CW INDUSTRIES PERSONNEL, WITHOUT WRITTEN AUTHORIZATION FROM CW INDUSTRIES INCORPORATED, SOUTHAMPTON, PENNSYLVANIA USA.

SWITCHING CIRCUIT: 	Panel Cutout 		Rating 16A 30V DC
	Contact Resistance 20mΩ Initial (Max.)		Insulation Resistance DC 500V 100MΩ (Min.)
Dielectric Strength 1500VAC for 1 Minute		Switch Function ON - OFF	

SWITCH COLOR:

Base - Gray
 Actuator - Black,
 Type Hard PC

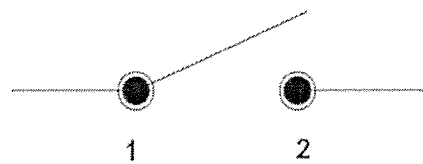
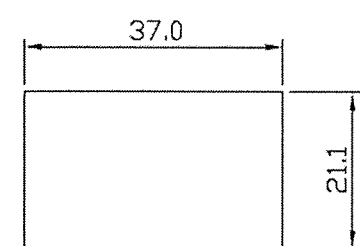
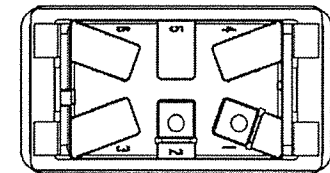
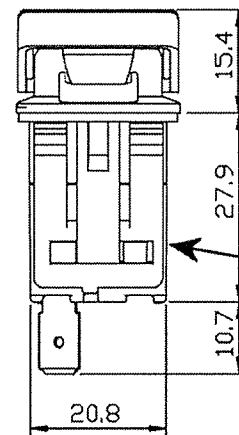
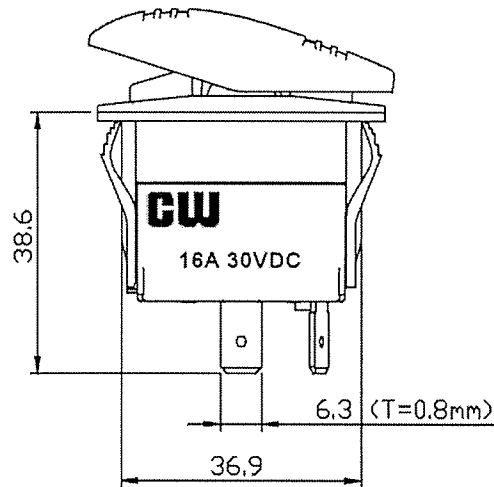
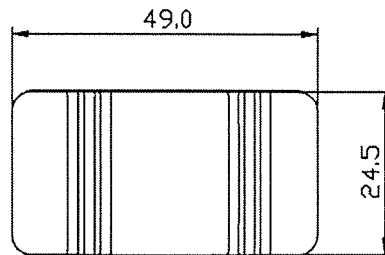

MM YY

Date
 Code
 Label

Tolerances Unless Otherwise Specified: +/- .012"/0.3mm.

RoHS Compliant

 Southampton, Pa. 18966 Tel 215.355.7080/www.cwind.com	Date Drawn: 10-07-13	Rev. 0	Unit: mm	Checked By: <i>G. Guld</i>
	Title: ROCKER SWITCH		CW P/N: GRB114CNNNABD1	