







THIS INFORMATION IS CONFIDENTIAL AND PROPRIETARY TO CW INDUSTRIES INCORPORATED AND ITS AFFILIATES. IT MAY NOT BE DISCLOSED TO ANYONE, OTHER THAN CW INDUSTRIES PERSONNEL, WITHOUT WRITTEN AUTHORIZATION FROM CW INDUSTRIES INCORPORATED, SOUTHAMPTON, PENNSYLVANIA USA.

Rating	16A 125V AC 1/3HP 10A 250V AC 1/2HP 16A 12VDC 6A 28VDC		Mounting Hole		Terminal Style 0 2  .187" SQ 0 5  SO 0 9  PC 1 0  PC ANGLE 1 2  SO
	20A 12V DC				
Contact Resistance	50m ohm max.		Thickness	X	Y
Insulation Resistance	DC 500V 100M ohm min.		0.75 - 1.25	19.2 - 0.1	13.0 + 0.1
Dielectric Strength	AC 1500V 1 minute		1.25 - 2.00	19.4 - 0.1	13.0 + 0.1
Operating Temperature	-25°C ~ 85°C		2.00 - 3.00	19.8 - 0.1	13.0 + 0.1

SWITCH FUNCTION

Different button

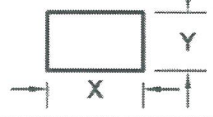
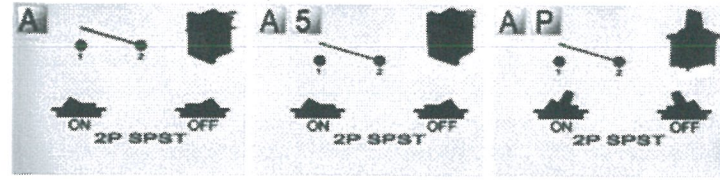

Illuminated / Different button

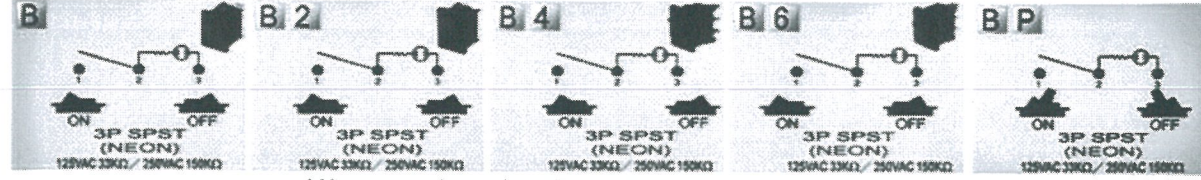

Different position / Different button

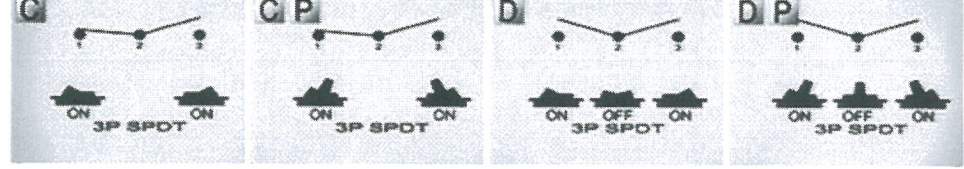

Momentary / Different button

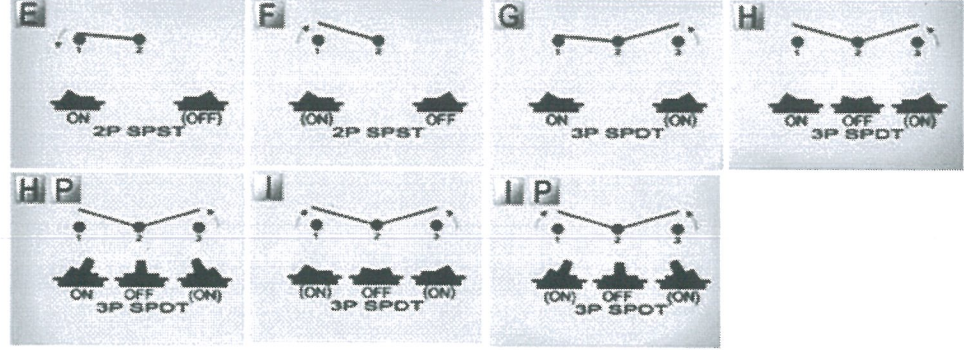

Independent circuit / Different button

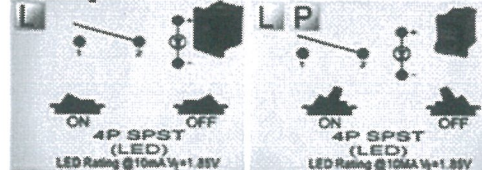

() = Momentary Function

Frames are nylon (UL flame: 94-2V).
Illuminated actuators are molded in PC, available in Red, Amber or Green colors.
Terminals are silver plated brass.
Optional waterproof cover is available for IP-55 rating.
A variety of button options available.

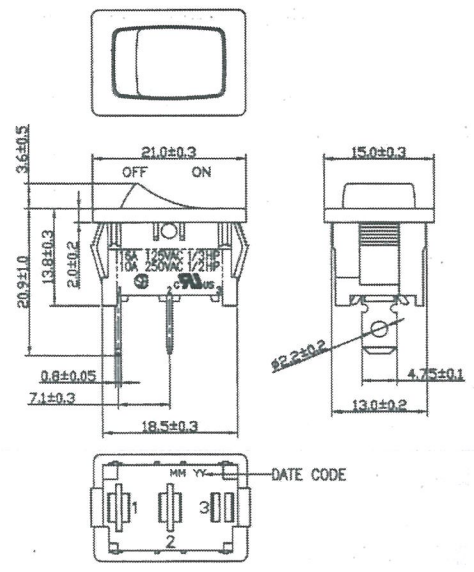

RoHS Compliant

2	Removed CW logo. APhilip 11/28/22
1	Updated ratings. 3-01-13.

CW INDUSTRIES
Southampton, Pa. 18966
Tel 215.355.7080/www.cwind.com

Date Drawn: 2/03/11
Title: **ROCKER SWITCH**

Rev. 2
Unit: mm
Checked By: *G. GOLD*
CW P/N: **GRB066XSERIES**