

GPB527 Push Button Switch

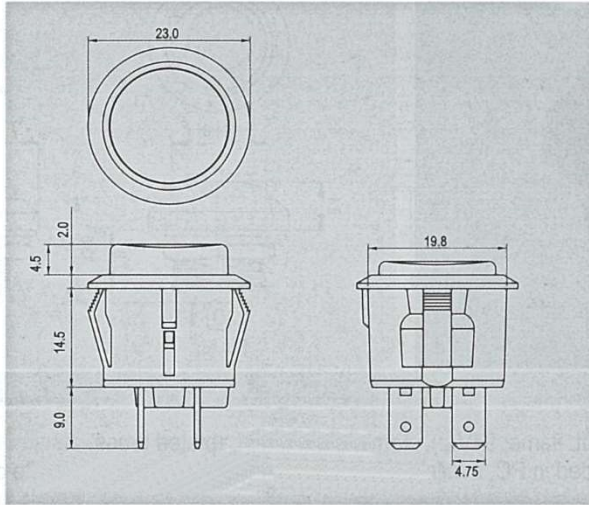

Rating
10A 125V/6A 250V AC 1/2HP 125V-250V AC
Contact resistance
50mΩ Max
Insulation resistance
DC 500V 100MΩ Min
Dielectric strength
AC 1000V 1 minute
Cut-out

$\pm 0.7 \sim 3.0$ mm max

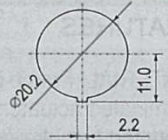

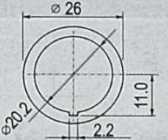

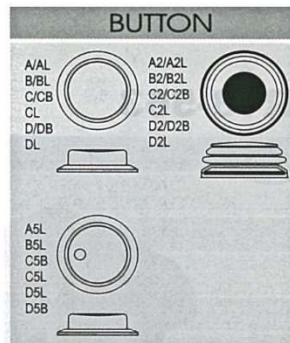





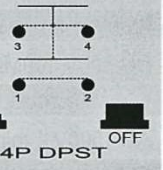
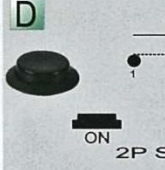
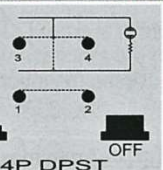

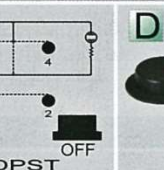
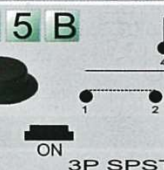
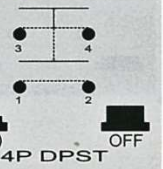
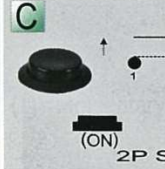
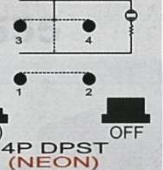
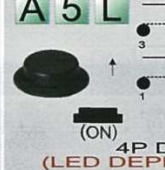
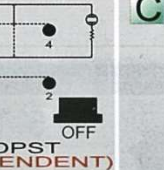
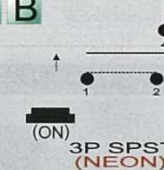
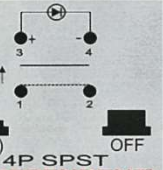
FEATURES

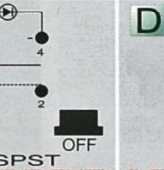
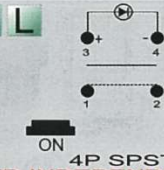
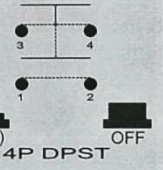
- * MATERIAL: Frame is nylon (UL flame:94V-2). Terminals are silver plated brass.
- * Illuminated actuators are molded in PC, available with red, amber, green, blue and white colors.
- * Snap-in mounting, easy to install switch into panel.
- * Watertight and dustproof to fit IP65.

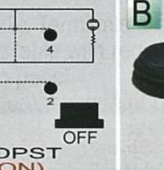
Cut-out for X2 BUTTON

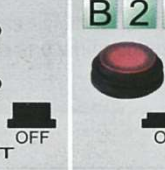
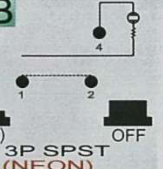
$\pm 0.7 \sim 2.5$ mm max

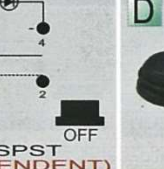
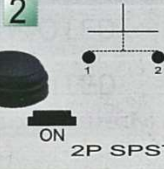

GPB527 Push Button Switch

FUNCTION		TERMINAL
Non-illuminated button		0 2  .187" SQ
B	 4P DPST	
D	 2P SPST	
Illuminated / Different button		
BL	 4P DPST (NEON) 125VAC 33KΩ / 250VAC 150KΩ	
B5L	 4P DPST (LED DEPENDENT)	
D5B	 3P SPST (LED DEPENDENT)	
DB	 3P SPST (NEON) 125VAC 33KΩ / 250VAC 150KΩ	
Momentary / Non-illuminated button		
A	 4P DPST	
C	 2P SPST	
Momentary / Non-illuminated / Different button		
AL	 4P DPST (NEON) 125VAC 33KΩ / 250VAC 150KΩ	
A5L	 4P DPST (LED DEPENDENT)	
CB	 3P SPST (NEON) 125VAC 33KΩ / 250VAC 150KΩ	
C5B	 3P SPST (LED DEPENDENT)	
Independent circuit		
CL	 4P SPST (LED INDEPENDENT)	
C5L	 4P SPST (LED INDEPENDENT)	
DL	 4P SPST (LED INDEPENDENT)	
D5L	 4P SPST (LED INDEPENDENT)	
Watertight		
A2	 4P DPST	
A2L	 4P DPST (NEON) 125VAC 33KΩ / 250VAC 150KΩ	
B2	 4P DPST	
B2L	 4P DPST (NEON) 125VAC 33KΩ / 250VAC 150KΩ	
C2	 2P SPST	
C2B	 3P SPST (NEON) 125VAC 33KΩ / 250VAC 150KΩ	
C2L	 4P SPST (LED INDEPENDENT)	
D2	 2P SPST	
D2B	 3P SPST (NEON) 125VAC 33KΩ / 250VAC 150KΩ	
D2L	 4P SPST (LED INDEPENDENT)	