

THIS INFORMATION IS CONFIDENTIAL AND PROPRIETARY TO CW INDUSTRIES INCORPORATED AND ITS AFFILIATES. IT MAY NOT BE DISCLOSED TO ANYONE, OTHER THAN CW INDUSTRIES PERSONNEL, WITHOUT WRITTEN AUTHORIZATION FROM CW INDUSTRIES INCORPORATED, SOUTHAMPTON, PENNSYLVANIA USA.

Rating	3A. 125V , 1.5A 250V AC	
Contact Resistance	50m ohm max.	
Insulation Resistance	DC 500V 100M ohm min.	
Dielectric Strength	AC 1000V 1 minute	

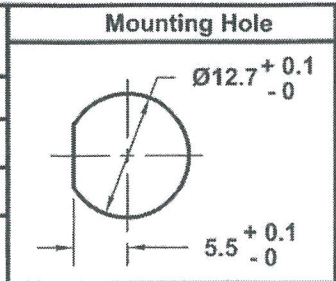

Cut-Out 3 mm thk. max

MATERIAL:

- Housing: Nylon #66
- Button: Nylon #66
- Terminals: Silver plated, Copper Alloy

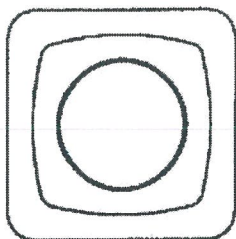

FUNCTION

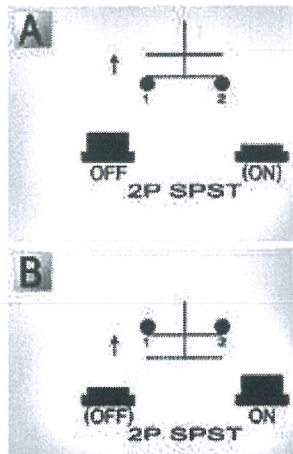

() = Momentary

TERMINAL

- 0 3 .110" SQ
- 0 5 SO

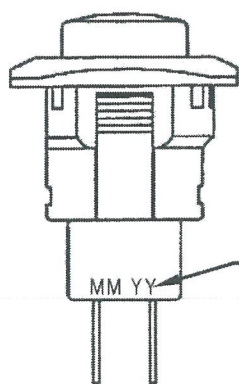

Date Code

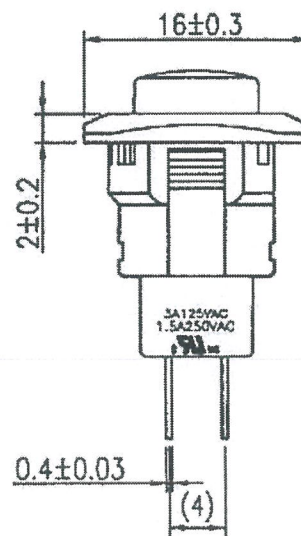
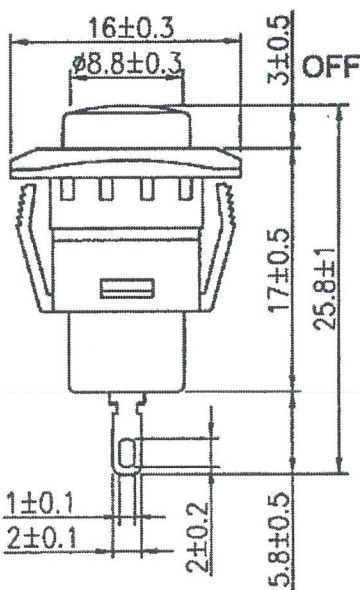

Flat

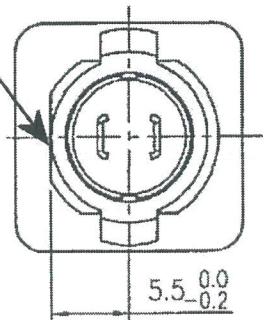

Order Chart					
Series	Terminal	Frame Color (Std. Black)		Actuator Color (Std. Black)	
GPB510	X XX	B	B	X	- Printing

MASTER

R13-510A-05

RoHS Compliant

- 2 Removed Logo & added order chart. DW 1/16/23
- 1 Updated dimensions and views. 10/17/13.

CW INDUSTRIES
Southampton, Pa. 18966
Tel 215.355.7080/www.cwind.com

Date Drawn: 2/09/11

Rev. 2

Unit: mm

Checked By: *G. GULD*

Title: **PUSH BUTTON SWITCH**

CW P/N: **GPB510XSERIES**