



THIS INFORMATION IS CONFIDENTIAL AND PROPRIETARY TO CW INDUSTRIES INCORPORATED AND ITS AFFILIATES. IT MAY NOT BE DISCLOSED TO ANYONE, OTHER THAN CW INDUSTRIES PERSONNEL, WITHOUT WRITTEN AUTHORIZATION FROM CW INDUSTRIES INCORPORATED, SOUTHAMPTON, PENNSYLVANIA USA.

Rating	3A. 125V , 1.5A 250V AC		Mounting Hole	
Contact Resistance	50m ohm max.			
Insulation Resistance	DC 500V 100M ohm min.			
Dielectric Strength	AC 1000V 1 minute			
Switch Function	2P SPST OFF- (ON) , Push On			

( ) = Momentary Function

Cut-Out 3 mm thk. max

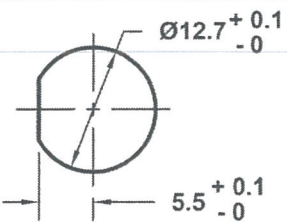
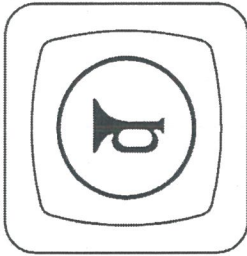

Material:

Frame: Nylon#66, Black

Actuator: Nylon#66, Black

Bottom Cover: PBT+30%GF, Black

Printing: White

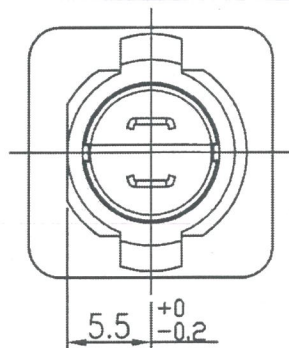
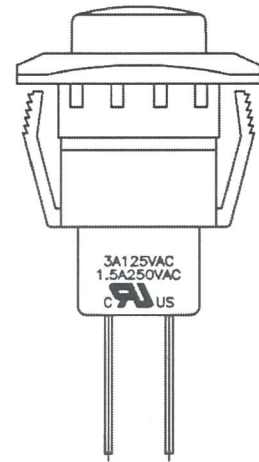
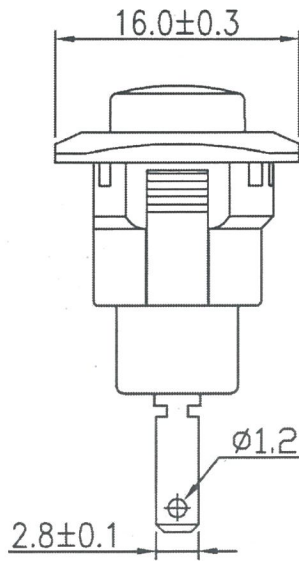
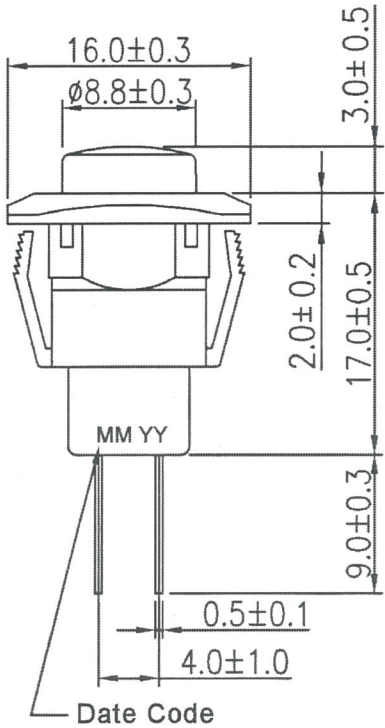

Order Chart	
Series	Terminal
GPB510	A 03
B	B 19
Function	Actuator Color
	Printing

RoHS Compliant

**MASTER**

R13-510A-03-BB-19

2	Added Printing & Color. DW 10/03/24
1	Removed Logo & added order chart. DW 1/16/23

**CW INDUSTRIES**  
Southampton, Pa. 18966  
Tel 215.355.7080/www.cwind.com

Date Drawn: 4/05/13

Rev. 2

Unit: mm

Checked By: *G. GOLD*

Title: **PUSH BUTTON SWITCH**

CW P/N: **GPB510A03BB-19**